



SARIÇAM

ARMS DEFENCE INDUSTRY

2025
CATALOG

At the heart of the SS-4 is the Auto-Regulated Gas-Operated piston system. This system, designed for combat operations is both reliable and durable, ensuring functionality in rugged conditions and harsh environments. The dual pistons adjust to varied pressures of ammunition ensuring consistent cycling even in harsh environments. The hard chrome pistons are self cleaning minimizing the need for maintenance while in the field.



The receiver is made of 7075 aircraft grade aluminum ensuring a durable and long lasting shotgun. All SS-4 models feature commonly available Mobil chokes to ensure optimal patterns with any ammunition at any distance. Tactical models include a notched stock tube ensuring compatibility with both solid and telescoping stocks.

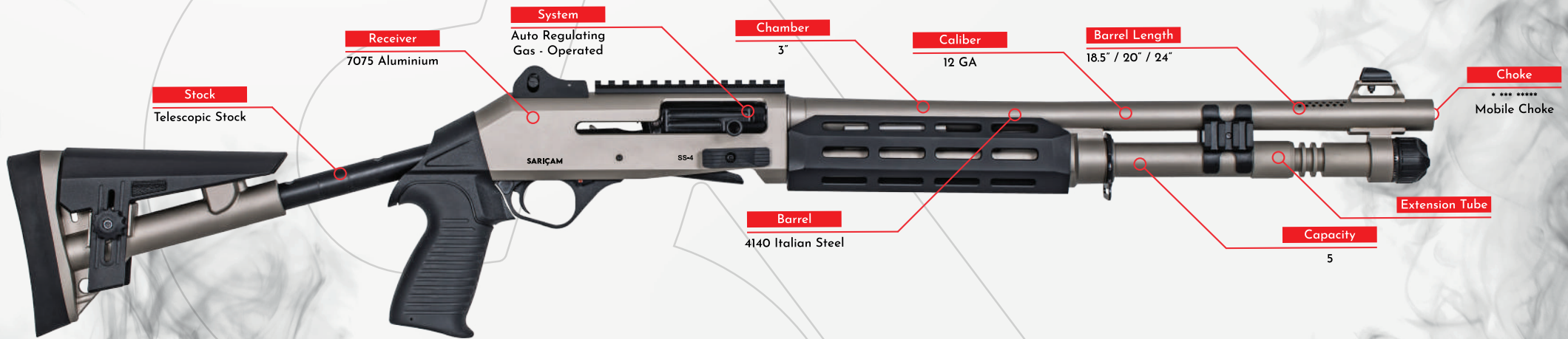

Introducing the SS-4 Speed Pro.

Fully loaded with custom features, the SS-4 Speed Pro is ready to rock right out of the box. Included Mobil chokes ensure the versatility to dominate any range. The muzzle comes professionally ported to reduce muzzle rise and recoil. A chrome lined bore ensures easy cleaning and durability for thousands of rounds. Bring your reloads up to speed with the expanded feed port and factory custom extended bolt release. An included M-Lok compatible handguard and picatinny barrel clamp allow you to attach all of your competition and home defense accessories, giving you the edge.

SS-4
SEMI AUTOMATIC



M-101



RED M-102



BRONZE M-103



USA FLAG M-104



OD GREEN M-105



CERACOTE M-106

GAS OPERATED - ROTATING BOLT

System	Auto Regulating Gas - Operated	Barrel Length	18.5" / 20" / 24"
Caliber	12 GA	Barrel	4140 Italian Steel
Chamber	3"	Receiver	7075 Aluminium
Capacity	5	Choke	* *** ***** / Mobile Choke



M-107



CERACOTE **M-108**



USA FLAG **M-109**



M-110



M-111



OD GREEN **M-112**

GAS OPERATED - ROTATING BOLT

System	Auto Regulating Gas - Operated	Barrel Length	18.5" / 20" / 24"
Caliber	12 GA	Barrel	4140 Italian Steel
Chamber	3"	Receiver	7075 Aluminium
Capacity	5	Choke	* *** ***** / Mobile Choke



GAS OPERATED - ROTATING BOLT

System	Auto Regulating Gas - Operated	Barrel Length	18.5" / 20" / 24"
Caliber	12 GA	Barrel	4140 Italian Steel
Chamber	3"	Receiver	7075 Aluminium
Capacity	5	Choke	* *** ***** / Mobile Choke

TACTICAL



M-120



MARINE **M-121**

SS-4 Speed Pro Introducing the SS-4 Speed Pro. Fully loaded with custom features, the SS-4 Speed Pro is ready to rock right out of the box. Included Mobil chokes ensure the versatility to dominate any range. The muzzle comes professionally ported to reduce muzzle rise and recoil.

A chrome lined bore ensures easy cleaning and durability for thousands of rounds. Bring your reloads up to speed with the expanded feed port and factory custom extended bolt release. An included M-Lok compatible handguard and picatinny barrel clamp allow you to attach all of your competition and home defense accessories, giving you the edge.

System	Auto Regulating Gas - Operated	Barrel Length	18.5" / 20" / 24"
Caliber	12 GA	Barrel	4140 Italian Steel
Chamber	3"	Receiver	7075 Aluminium
Capacity	5	Choke	* *** ***** / Mobile Choke

GAS OPERATED - ROTATING BOLT



M-113



M-114



GRAY M-115



OD GREEN M-116

GAS OPERATED - ROTATING BOLT

System	Auto Regulating Gas - Operated	Barrel Length	24" / 26" / 28"
Caliber	12 GA	Barrel	4140 Steel
Chamber	3"	Receiver	7075 Aluminium
Capacity	3	Choke	* *** ***** / Mobile Choke

The 7075 receiver is strong yet lightweight making the SS-2 a dream to carry. Despite being a featherweight, the smooth cycling action provides a low recoiling shooting experience. The integrated dovetail allows for the installation of optics. Furniture is available in rugged polymer and beautiful Turkish walnut.



Barrel lengths from 18.5 to 28 inches ensure there is a barrel length for your use. The 28 inch field barrel swings well for busting clays or hunting birds. The 18.5 inch model is great for home defense and tactical shooting. The chrome lined bore is easy to clean and the included Mobil chokes allow the perfect pattern at any distance. 18.5 inch models feature ghost ring sights for accuracy with slugs or tight patterning buckshot.

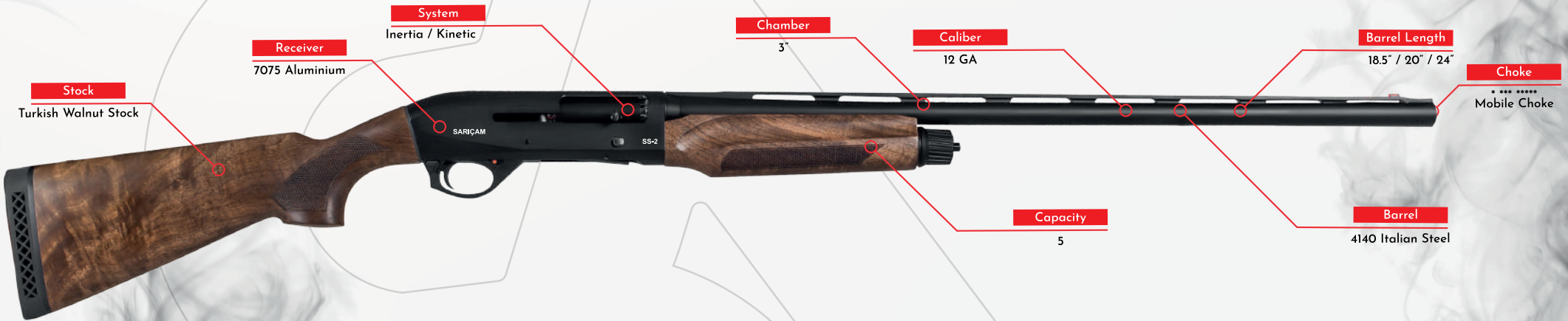

Sarıçam's Inertia driven SS-2 is the shotgun you need for long days in the field. The ultra reliable Inertia system has fewer moving parts ensuring a lightweight and fast cycling semi auto. No pistons to clean or lose makes maintaining this powerhouse as easy as it gets. Whether you are hunting doves or hitting birds on the sporting clays course, the SS-2 ensures ease of carry for long hours in the field. The SS-2 combo includes the 28 inch field barrel AND the 18.5 inch security barrel with ghost ring sights so one gun has the versatility to do it all.

SS-2
INERTIA / KINETIC



K-101



K-102



K-103



TIMBER K-104

INERTIA / KINETIC

System

Inertia / Kinetic

Barrel Length

26" / 28"

Caliber

12 GA

Barrel

4140 Italian Steel

Chamber

3"

Receiver

7075 Aluminium

Capacity

5

Choke

* *** ***** / Mobile Choke

TACTICAL



K-105



K-106



GRAY K-107



K-108



K-109

INERTIA / KINETIC

System	Inertia / Kinetic	Barrel Length	18.5" / 20" / 24"
Caliber	12 GA	Barrel	4140 Steel
Chamber	3"	Receiver	7075 Aluminium
Capacity	3 / 5 / 10	Choke	* *** ***** / Mobile Choke

The TX-12 is Sariçam's entry into the law enforcement market. Issued to law enforcement agencies around the globe, the TX-12 provides an economical and reliable option for police and security agencies. The gas piston system ensures reliability in defensive situations.



The 7075 Aircraft Aluminum receiver houses an 18.5 inch barrel, perfect for close quarters operation. The external choke tubes allow shooters to adjust the pattern based on their choice of ammunition and situation. The chrome lined 4140 steel barrel ensures durability in the harshest conditions.

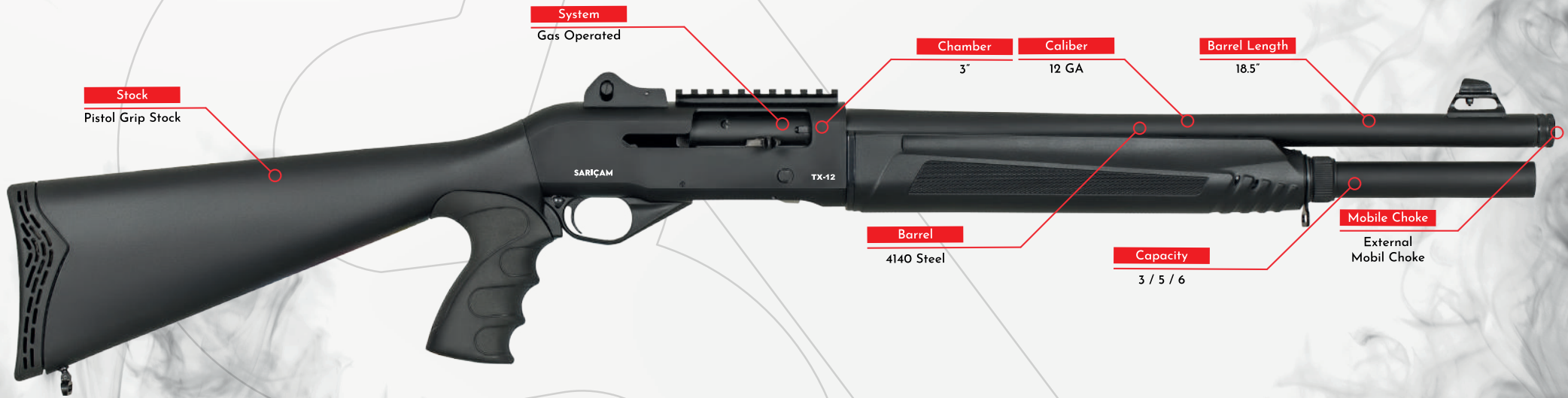

TX-12

SEMI AUTOMATIC



T-101



T-102

GAS OPERATED

System	Gas Operated	Barrel Length	18.5"
Caliber	12 GA	Barrel	4140 Steel
Chamber	3"	Receiver	7075 Aluminium
Capacity	3 / 5 / 6	Choke	External Mobile Choke

Sarıçam's Bullpup shotgun is the BP-12. The strong 7075 Aircraft Aluminum upper receiver and handguard provide the rigidity and strength required to handle 12 gauge power. Meanwhile the polymer lower receiver keeps the weight down while keeping the BP-12 balanced. On top of the receiver is a full length picatinny rail for attaching optics and the included flip up back-up iron sights. On either side of the front handguard are M-Lok compatible slots for attaching accessories.



Inside the BP-12 is a robust and reliable gas piston system. In order to keep the BP-12 compact the piston and recoil spring are contained forward the action. This means no buffer tubes that add length to the overall package. Being a Bullpup, the action is behind the trigger. This guarantees ultimate compactness. Since the gas system is located forward the receiver, the action remains clean and free of debris.

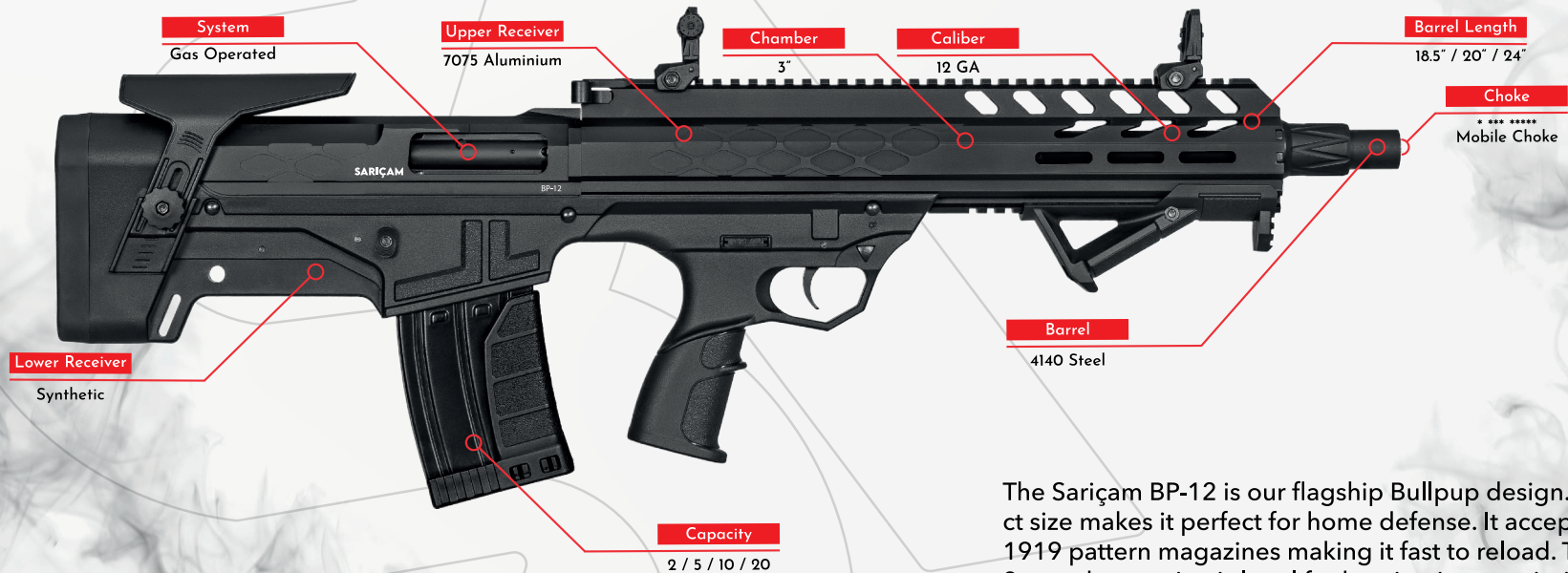

The Sarıçam BP-12 is our flagship Bullpup design. It's compact size makes it perfect for home defense. It accepts standard 1919 pattern magazines making it fast to reload. The included 2 round pattern magazine is legal for hunting in many jurisdictions. The 5 round magazine provides easy reloads in a compact package. For added firepower, aftermarket 10 round magazines are available. The magazine well is located behind the grip making reloads easy. It has a top mounted, non reciprocating charging handle to make the BP-12 snag free. An integral qd socket allows for the use of modern QD slings. The BP-12 is your choice when compact size is a requirement.

BP-12
BULLPUP



B-101



BRONZE
B-102



B-103



CREACOTE
B-104

BULLPUP

System

Gas Operated

Barrel Length

18.5" / 20"

Caliber

12 GA

Barrel

4140 Steel

Chamber

3"

Receiver

7075 Aluminium

Capacity

2 / 5 / 10 / 20

Choke

* *** ***** / Mobile Choke

7075 Aircraft Aluminum upper receiver and handguard provide the rigidity and strength required to handle 12 gauge power. Meanwhile the aluminum lower receiver keeps the weight down while keeping the MF-12 balanced. On top of the receiver is a full length picatinny rail for attaching optics or the included carry handle iron sight. The carry handle sight is



On either side of the front handguard are picatinny compatible rails for attaching accessories. Rails are provided only where they are needed, keeping the MF-12 slim and easy to handle. The pistol grip and safety are properly located to be ergonomic and intuitive to use.



The name of the game when it comes to 12 gauge shotguns is firepower and that's exactly what you'll get with the MF-12. Capable of handling 3 inch magnums shells, this powerhouse has firepower in the bag. The included 2 round magazine makes it versatile and legal for hunting while the 5 round magazine provides compact firepower for fast reloads. If you need extra capacity the MF-12 accepts 1919 pattern magazines. And for ultimate capacity the available 20 round drum provides maximum firepower before having to reload.

MF-12

VERTICAL MAGAZINE



MF-101

Metal Lower Receiver



MF-102

Metal Lower Receiver



MF-103

SARIÇAM MF-9
9.5"



MF-104

VERTICAL MAGAZINE

System	Gas Operated	Barrel Length	18.5"
Caliber	12 GA	Barrel	4140 Steel
Chamber	3"	Receiver	7075 Aluminium
Capacity	2 / 5 / 10 / 20	Choke	* ** ***** / Mobile Choke

The Sariçam S-47 is the newest addition to the Sariçam family. It has a long stroke piston driven system that provides smooth shooting and reliability. An adjustable gas system ensures reliability and manageable recoil with a variety of ammunition. The rotating bolt system guarantees strong lockup so the S-47 can handle loads up to 3" magnums.



The one piece milled steel receiver provides rigidity and strength. Attached to the steel dust cover is a standard picatinny rail for mounting optics. Fine Turkish walnut furniture makes this one of the most beautiful Kalashnikov pattern shotguns on the market. The Smoothbore slug barrel promotes consistent patterns with both slugs and shot.



The S-47, where power meets capacity. Based on the venerable Kalashnikov operating system the S-47 provides the perfect combination of firepower and reliability. The included 5 or 10 round magazine ensures plenty of firepower and a fast reload. Since it accepts standard 12 gauge Saiga pattern magazines, aftermarket options are available to expand your firepower even further.

S-47
SEMI AUTOMATIC



A-101



A-102

GAS OPERATED - ROTATING BOLT

System	Gas Operated / Rotating Bolt	Barrel Length	18.5"
Caliber	12 GA	Barrel	4140 Steel
Chamber	3"	Receiver	7075 Aluminium
Capacity	5+1 / 10+1	Choke	Slug Barrel

Coming in at a featherweight 6.5 lbs The Sariçam PA-12 features a rugged 7075 aircraft grade aluminum receiver. This 12 gauge pump action is a dream to carry in the field. The 4140 steel barrel and bolt can chamber shells up to 3" in length. The polymer stock is lightweight and durable while the available Turkish Walnut furniture is stunning. It will look great on your shoulder and on your gun rack.



The barrel comes in multiple lengths including 18.5 and 20 inches, perfect for home security, as well as 24, 26, and 28 inches suitable for a variety of game and clay shooting tasks. The muzzle is threaded for Mobil chokes. The chrome lined bore is easy to clean and will last for years to come.

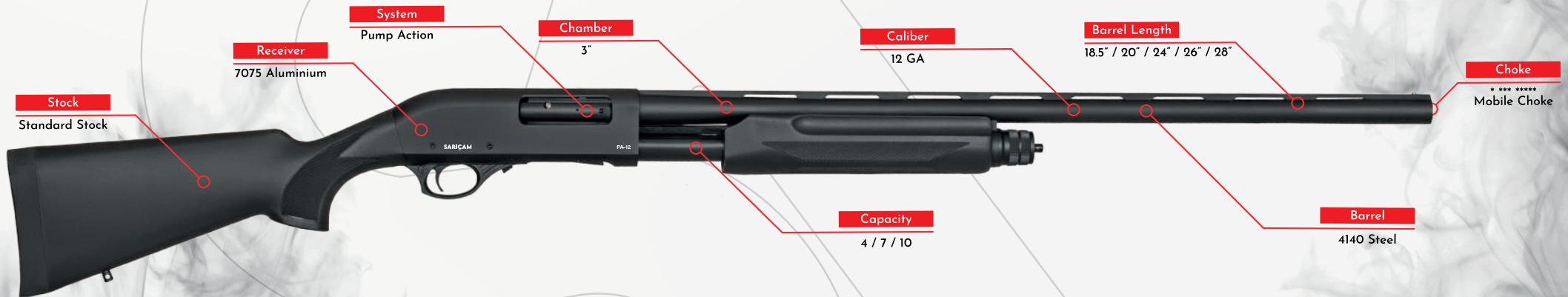

Reliability is the name of the game with pump action shotguns and the PA-12 is no different. With no piston to foul up and no Inertia system that requires heavy ammunition, the PA-12 will cycle anything from the lightest target loads up to the most powerful 3" magnums.

PA-12
PUMP ACTION



PA-101



PA-102

PUMP ACTION

System	Gas Operated	Barrel Length	18.5" / 20" / 24" / 26" / 28"
Caliber	12 / 20 GA	Barrel	4140 Steel
Chamber	3"	Receiver	7075 Aluminium
Capacity	4 / 7 / 10	Choke	* *** ***** / Mobile Choke



PA-103



PA-104



PA-105

PUMP ACTION

System	Gas Operated	Barrel Length	18.5" / 20"
Caliber	12 GA	Barrel	4140 Steel
Chamber	3"	Receiver	7075 Aluminium
Capacity	5 / 6 / 7	Choke	* *** ***** / Mobile Choke

The SBS-12 by Sariçam is a simple yet reliable double barrel shotgun with all of the features you'd expect from a side by side. The two tone receiver looks fantastic in contrast to the beautiful Turkish walnut stock. The dark blued finish on the modern 4140 steel barrel is deep black and luxurious. This shotgun will always look right at home, whether it is defending the homestead, hunting birds, or hanging above the fireplace.



The barrels feature Mobil chokes so the SBS-12 can handle a variety of loads. Since it is a break action it can handle everything from mini shells up to 3" magnums. The tang mounted safety allows you to choose whether the left or right barrel will shoot first. The single trigger allows for a consistent trigger pull between both barrels. The twin extractors gently hand you the shells from the chamber so you don't have to chase them across the range.



The SBS-12 combines new materials with an old fashioned aesthetic. Whether you're into cowboy action shooting, rabbit hunting, or busting clays the SBS-12 will bring the joy of nostalgia into the 21st century. The best part is you can shoot it as much as you'd like, and unlike relics of the past it won't wear out from shooting modern ammunition.

SBS-12
SIDE BY SIDE



SIDE BY SIDE

System	Break Open	Barrel Length	18.5" / 20" / 24" / 28"
Caliber	12 GA	Barrel	4140 Steel
Chamber	3"	Receiver	7075 Aluminium
Capacity	2	Choke	* *** ***** / Mobile Choke

The Sariçam DB-12 is Sariçam's entry into the over under market. Its light weight ensures speed when leading a target. The Turkish Walnut stock and dark blued barrel finish make this shotgun a thing of beauty.



The 7075 aircraft grade aluminum receiver keeps the weight down and the balance forward resulting in a fast handling but stable shooting scattergun. The chrome lined bores are easy to clean and resistant to the elements. Mobil pattern chokes allow you to dust clays on any course.



A lightweight over under is favored among top wingshooters and the DB-12 fits the bill perfectly. Whether is smashing sporting clays or hunting upland birds it is sure to delight. The Turkish Walnut furniture is sure to attract some attention at the trap field and will look even better as you turn clay pigeons into powder.

DB-12
OVER & UNDER



U-101



U-102



U-103



U-104

OVER UNDER

System	Break Open	Barrel Length	28" / 30"
Caliber	12 GA	Barrel	4140 Steel
Chamber	3"	Receiver	7075 Aluminium
Capacity	2	Choke	* *** ***** / Mobile Choke

Sometimes you just need something simple that just plain works. That's what the Single Barrel SB-12 is about. Simplicity. This single shot shotgun features a 3 inch chamber to handle a variety of ammunition.



At the other end of the chrome lined barrel is an easily swappable Mobil choke to ensure perfect patterns at any distance with any ammunition. This break action shotgun provides a simple and lightweight package when you don't need the extra features found on other shotguns.

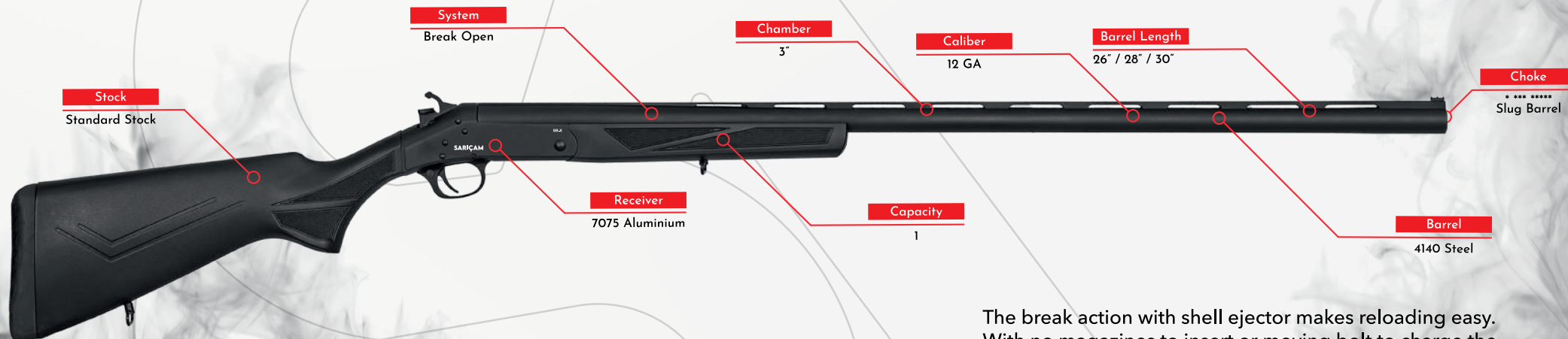

The break action with shell ejector makes reloading easy. With no magazines to insert or moving bolt to charge the SB-12 is easy to use for new shooters or for those who want ultimate simplicity.

SB-X
SINGLE BARREL



Ejector
X-101



Ejector
X-102

SINGLE BARREL

System	Break Open	Barrel Length	18.5" / 20" / 24" / 28" / 30"
Caliber	12 GA	Barrel	4140 Steel
Chamber	3"	Receiver	7075 Aluminium
Capacity	1	Choke	* ** ***** / Slug Barrel



S-101



S-102



S-103

SINGLE BARREL

System	Break Open	Barrel Length	18.5" / 20" / 24" / 28" / 30"
Caliber	12 / 20 / .410 GA	Barrel	4140 Steel
Chamber	3"	Receiver	7075 Aluminium
Capacity	1	Choke	* ** ***** / Slug Barrel

SS-4 SPARE PARTS

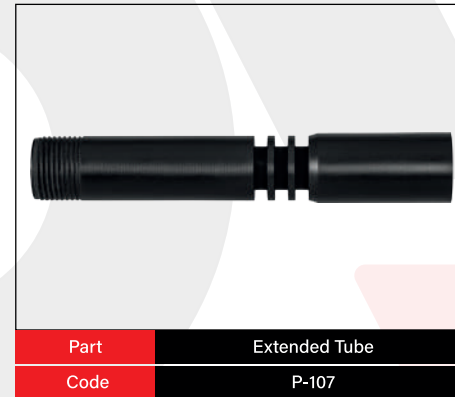
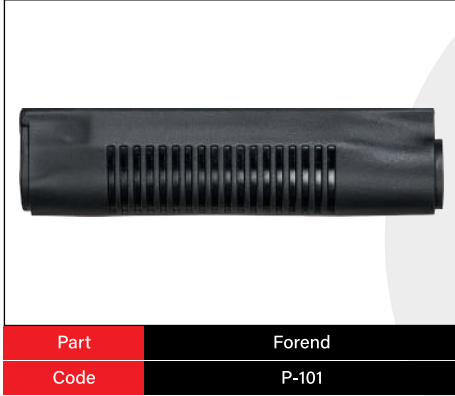

SS-4 SPARE PARTS

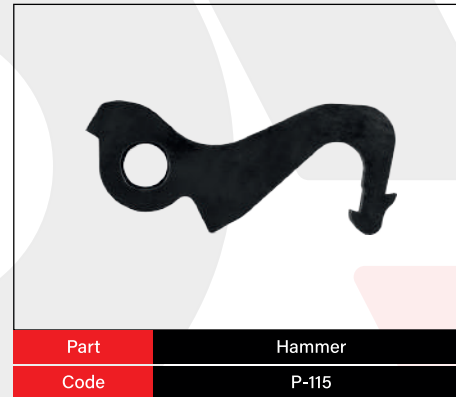
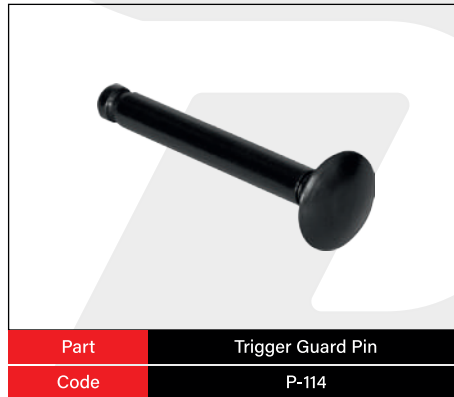
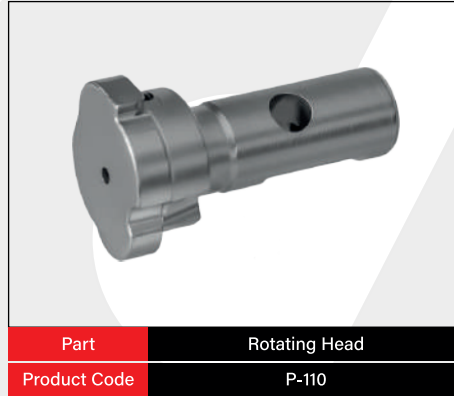
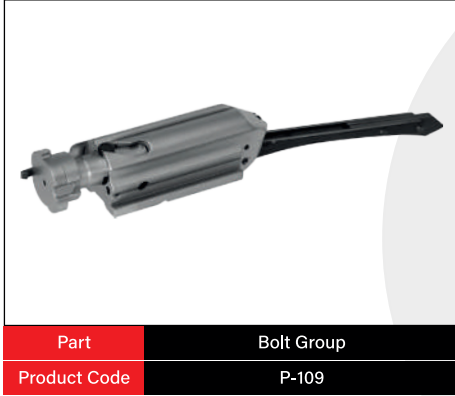

SS-4 SPARE PARTS

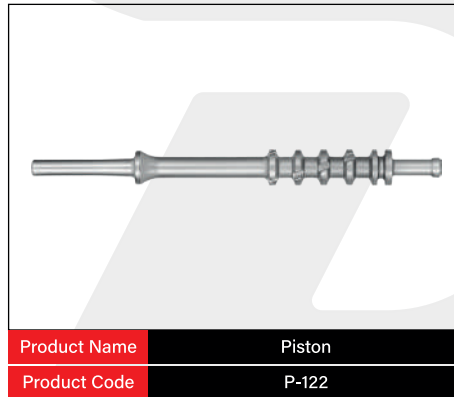
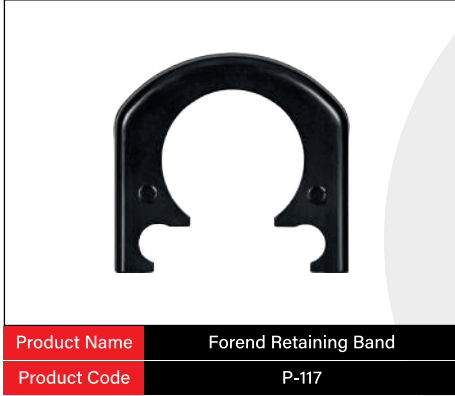

SS-4 SPARE PARTS

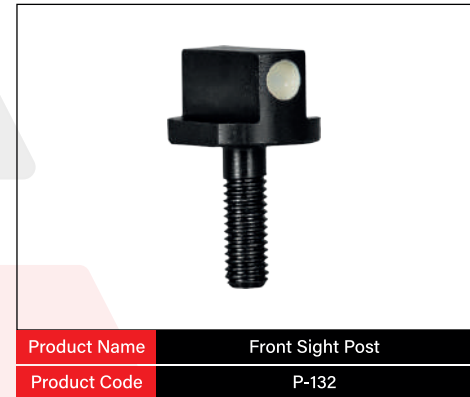
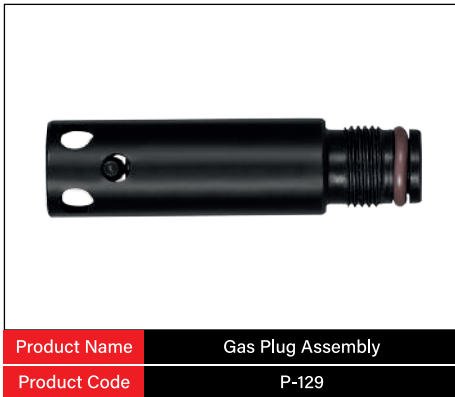
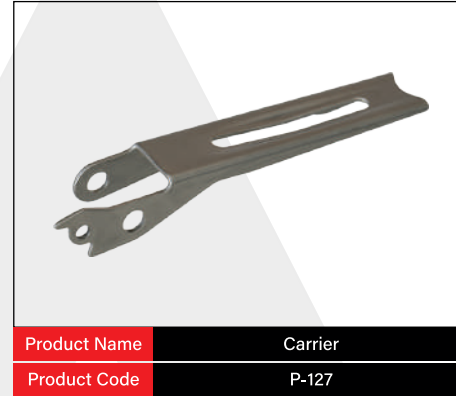
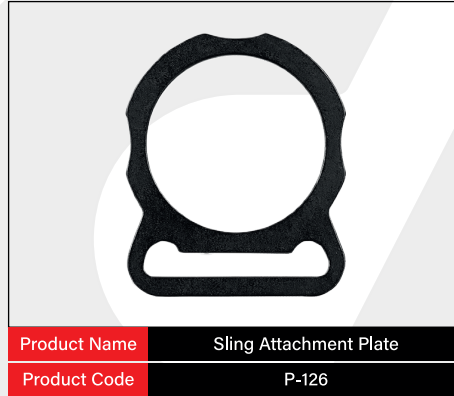

ABOUT US

We are assertive that in order to grow, develop and compete with competitors in the world market, it is necessary not only to produce, but also to produce with higher quality and to deliver on time, and with this understanding, Sarıçam Arms has made a name for itself with its innovations in the defense industry.

Its corporate understanding, which aims to respond one step ahead of customers' demands, has led Sarıçam Arms to open up not only to Turkey but to the whole world and has started to exist in the world market.

CONTACT



+90 530 717 98 96
+90 539 415 18 66



umit@saricamarms.com
export@saricamarms.com



www.saricamarms.com



Üzümlü Mah. Alparslan Türkeş Cad. No:79 - Beyşehir / KONYA/ TURKEY